

User Manual



Electronic Cash Register

CR 1200 series

...designed to Succeed

Dear valued customer!

On behalf of our proud company we wish to welcome you to the QUORION family of fine business machines. We sincerely hope you will appreciate the many benefits of being associated with a distinguished product name that represents both quality and commitment to customer satisfaction.

The QUORION cash register is fully customizable and yet simple to operate. Users can easily adapt it to any type of retail or scanning system. Moreover, our dynamic software generates a compatible environment for a wide array of peripheral devices. It is exactly this versatility and quality that has made us successful among our multinational customers.

It is therefore with great pride that we look forward to continuing our close collaboration with our customers.

Sincerely,

Your QUORION Team

Index

Introduction	6
Specifications	7
1. Keyboard	8
1.1 Keyboard Layout	8
1.2 Names of Keys and their Function	9
1.3 Control Lock and Control Lock Keys	11
2. Basic Sales Functions	12
2.1 Signing on a Clerk	12
2.2 Making a Sale Using an Open Department	13
2.3 Making a Sale Using a Preset Dept./PLU	13
2.3.1 Creating a PLU during a Sale	14
2.4 Ringing up Multiple items in a Sale	15
2.5 Tendering a Sale	16
3. Voiding and Negative Transactions	16
3.1 Clearing a Numeric Entry	16
3.2 Correcting the Last Entry	17
3.3 Voiding Items during a Sale	17
3.4 Refunding Items outside of a Sale	18
3.5 Giving Discounts during a Sale	19
3.6 Cancellation of a Sale	21
3.7 Voiding a Complete Sale	21
4. Advanced Sales Functions	21
4.1 Department Shifts	21
4.2 PLU Price Shifts	21
4.3 Foreign Currency Function	22
4.4 Holding a cash Sale	23
4.5 Receipt On/Off & Duplicate Receipt	23
4.6 Time and Date Functions	23
4.7 No Sale Function	23
4.8 Pay-Out and Received on Account	24
4.9 Split Tendering Function	24
4.10 Preset Price Override Function	25
5. Hospitality Functions	25
5.1 Assigning a Waiter	25

5.2 Opening a New/Existing Table	25
5.3 Printing the Bill and Closing off the Table	26
6. Advanced Table Functions	27
6.1 Voiding an Item in a Table	27
6.2 Transferring Tables	28
6.3 Splitting a Table.....	28
6.4 Using Condiments.....	29
6.5 Additional Balance Functions	31
7. Programming the Cash Register	33
7.1 Programming the Date and Time	33
7.2 Easy Programming.....	33
7.3 Programming Files.....	34
7.4 Scanning	36
7.5 Programming Network Features	38
7.5.1 Activating the Network.....	38
7.6 Training Mode.....	38
8. System Reports	38
8.1 User Report.....	39
8.2 Types of System Reports	40
8.3 Printing the Electronic Journal	40
9. Installing the Cash Register.....	41
9.1 Dot Matrix Printer	41
9.1.1 Installing of Paper Rolls.....	41
9.1.2 Installing and Replacing of Ribbon Cassette.....	42
9.2 Thermal printer	42
9.2.1 Paper Insertion.....	43
10. Accessories and Options.....	44
10.1 Ribbon Cassettes	44
10.2 Option PC Interface.....	44
11. Maintenance	44
11.1 Information on the Electromagnetic Compatibility and Safety	44
12. Character Code Charts.....	45
13. Peripheral Devices.....	46
13.1 Activation of a Serial Interface RS 232	46
13.2 Cables	46
13.2.1 PC-Cable.....	46

13.2.2 Printer-Cable	47
14. Error Messages	47
15. Test Routines	48
16. Battery operated system CR1200	50

Introduction

This electronic Cash Register is designed to help your business function smoothly by providing efficient register operations and accurate management reports. Start-up is quick and easy, yet there are many options that can be added and revised so that you can customize your operations for optimum productivity. Here are just a few of the Register's many valuable features:

- Up to 100 default departments allow you to categorize merchandise to be sold.
- Up to 20,000 PLU settings allow for fast, accurate entry of an item and record the items to be sold.
- Up to 16 clerks.
- Large front and rear display for easy operator and customer viewing.
- Automatic tax computation available for 8 different tax rates, including add-on and VAT.
- Periodic management reports provide up-to-date sales analysis, including mid-day, end-of-day, weekly or monthly totals.
- Memory protection maintains financial records during power outage.
- Cash Register displays time and automatically prints date and time on the receipt and transaction records.
- Training mode available for new users.
- Programmable keyboard - CUSTOMIZATION to meet your requirements.
- Up to 6 interfaces and fiscal memory expand the usage of your Cash Register.

In general, the functions of the CR 1200 series are the same. There are model-typical differences concerning printers, displays, and keyboards used.

Specifications



Operator Display
- 2 lines á 16 characters
- **8 lines a 16 characters**

Keyboard
- 128 flat keys

Printer
- 2 x 38 mm matrix
- 2 x 38 mm thermal
- 76 mm matrix
- **57mm Thermo**
- **Cutter**

1. Keyboard

1.1 Keyboard Layout











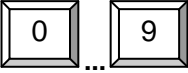







The keyboard consists 128 key locations which are freely programmable by your dealer according to your specific requirements.













1	2	3	4	5	6	7	8
9	10	11	12	13	14	15	16
17	18	19	20	21	22	23	24
25	26	27	28	29	30	31	32
33	34	35	36	37	38	39	40
41	41	43	44	45	46	47	48
49	50	51	52	53	54	55	56
57	58	59	60	61	62	63	64
65	66	67	68	69	70	71	72
73	74	75	76	77	78	79	80
<input type="checkbox"/>	<input type="checkbox"/>	CLERK #	PLU SHIFT	PRICE SHIFT	TAX SHIFT	↑ PAGE	↑ CURSOR
RECEIPT RECPT ON/OFF	JOURNA MODI #	X	PLU TYPE	R/A	P/O	↓ PAGE	↓ CURSOR
REFUN D	7	8	9	+ %	- %	(-) <small>SYS</small>	FCE
VOID DATE	4	5	6	PRINT INVOIC E	GUEST INVOIC E	# NS	CARD
EC TIME	1	2	3	TABLE SPLIT	TABLE TRANS	SUB TOTAL	CHECK
CLEAR	0	00	.	TABLE #	TABLE #	CASH ENTER	CASH ENTER

Default Layout of the 128' Keyboard

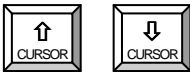
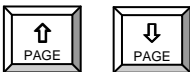
Note: The keys represented in this manual may appear differently on your keyboard due to programming preferences of the end user or the dealer. The keys are to be considered as a functional representation only.

1.2 Names of Keys and their Function

Key Label	Key Name	Function
	Numeric Keys	- used for entering numbers
	Receipt Feed Key	- advances the receipt paper
	Journal Feed Key	- advances the journal paper
	Clear Key	- clears incorrect entries before registration and stops the error alarm
	Error Correct Key	- deletes the last registration immediately after registration
	Void Key	- voids a previously entered transaction before finalization
	Multiplication/Time Key	- used for multiplication and displaying of the time
	Clerk Sign-On Key	- used to enter a preset clerk ID numeric code no.
	PLU Price Entry Key	- used to manually change a preset PLU price
	Price-Look-Up Key	- used to access preset PLU items
	Department Keys	- used to enter single or multiple items into the respective departments
	Received-On-Account	- records payments received by cash, check or credit cards
	Paid-Out Key	- used to record all cash paid out from the drawer
	Percent Plus-Key	- used to add preset or manually entered percentage to an item or sub total
	Percent Minus-Key	- used to deduct a preset or manually entered percentage from an item or sub total
	Minus or Coupon Key	- used to deduct a preset or manually entered amount
	No Sale Key	- used to print a reference code number or to open the cash drawer
	Sub Total Key	- displays the sub total during operations & prints 2 nd receipt

	Cash Key	- used for finalization of all registrations and transactions in cash
	Check Key	- used to tender payments made by check
	Card Key	- used to tender payments made by card
	Department Shift Key	- used to shift the levels of direct keys (e.g. 1 st level: dep. 1...25, 2 nd level: dep. 26...50)
	Foreign Currency Exchange	- calculate amounts in foreign currency
	Hold Key	- temporarily holds a sale, can be recalled later on
	Receipt On/Off Key	- receipt printer can be switched on or off
	Scroll Keys	- used for scrolling on the display to make a selection
	Page Up/Down Keys	- used for paging up or down on the display
	Table # Key	- used to open or close a table / tab
	Table Split	- separate single articles of a table to the invoice
	Table Transfer	- transfers an existing table to another table
	Print Invoice	- close table and print invoice
	Guest Invoice	- close table and print invoice including endorsement message
	Modifier Key	- preparation instructions for a particular article

Note: The keys above represent the default configuration. Actual keys may vary depending upon your customized keyboard layout (See Programming Manual).

1.3 Control Lock and Control Lock Keys

The control lock controls the operation of your Cash Register. It has six different positions for various operation modes. Each of the keys provide access to specific modes.

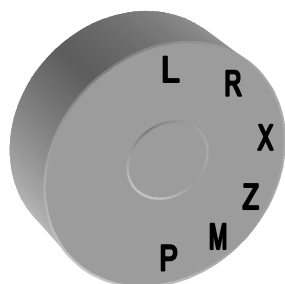

Control Lock

The following keys are provided:

- OP - Operator key for modes: L - R - X
 OW - Manager key for modes: L - R - X - Z - M
 OWP - Owner Program key for modes: L - R - X - Z - M - P

Key Pos.	Display	Mode/Function
L		- Lock Mode – turns off the Cash Register and disables all operations. All data is maintained in the memory.
R	SALE MODE 17 - 04 - 36	- Registration – Transaction Mode - used for all registrations and transactions (see Registration).
X	REPORT X	- Read Mode – used to print daily sales information reports at any time without clearing the totals (see Reports).
Z	REPORT Z	- Reset Mode – used to read daily and periodic sales information with clearing of totals.
M	Manager	- Manager options are opened, which are closed in other modes. Opens functions that have been programmed to be accessed by the manager only.
P	Programming	- Program Mode - used for programming of system function flags, DEPT, PLU, Logo, names and change of keyboard layout.

2. Basic Sales Functions

2.1 Signing on a Clerk

A clerk can be described in cash register terminology as the person who is assigned to the cash register. Every transaction made by that person is recorded and a report can be printed out at the end of a shift. The report will then show the total sales amount that each clerk registered.

The default factory setting is Clerk number 1. The user can change the Clerk in 4 distinct ways, depending upon how the cash register has been programmed.

Option 1:

If a general Clerk Key exists on the keyboard, enter first the clerk number and then press the Clerk Key.

Example: Activate Clerk 5, press 5 followed by the Clerk Key.

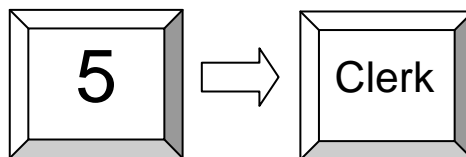

The programmed clerk name will appear on the display.

Option2:

Press the general Clerk Key on the keyboard. Depending on how many character lines the display has, the clerk names will be listed. Scroll down until the appropriate name has been found and press the Clerk Key again to confirm the selection.

Option3:

You can also program the specific Clerk Key on the keyboard. Simply press the correct Clerk Key to activate that person.

Option4: A Clerk can also sign on by inserting the specific clerk key in the control lock.

Note: It is possible to enforce a compulsory clerk for each transaction. This simply means that the users have to identify themselves before every transaction.

2.2 Making a Sale Using an Open Department

An open department refers to a department with an undetermined selling price. Items which have not been programmed are categorized into such departments. The salesperson determines the price during registration.

Example: To enter a price of \$2 for department 3, press the unit price including the cents, followed by the department key.

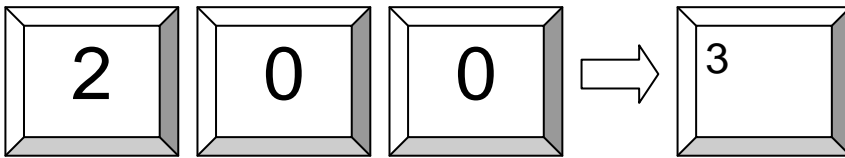

Your Store	
1 Department 3	2,00
<hr/>	
1 Total	2,00
Cash	2,00

2.3 Making a Sale Using a Preset Dept./PLU

If a price has already been programmed in the cash register for a specific department or PLU, simply press the key. To ring up PLU's which do not appear on the keyboard, press the PLU number followed by the PLU Key. If a PLU has a barcode programmed to it, then the Barcode number becomes the PLU Number.

Example: To ring up PLU 241, press the PLU number followed by the PLU Key.

Your Store	
1 PLU 241	5,00
<hr/>	
1 Total	5,00
Cash	5,00

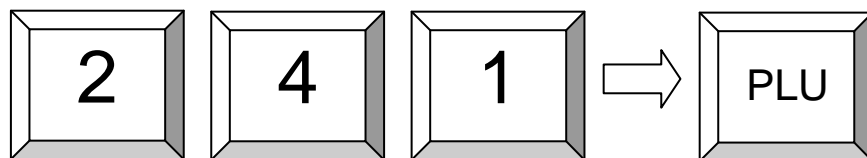

2.3.1 Creating a PLU during a Sale

Occasionally, a salesperson may have to enter a new item, which has not been programmed into the cash register. In such a case, your cash register will automatically prompt you to create this item. Press the Subtotal Key to confirm or the Cancel Key to exit the prompt. Once confirmed the cash register will ask you for the price. Upon entry of the price, press the Subtotal Key again to confirm. Then, enter the department that the PLU is linked to, press Subtotal to confirm. If the cash register has been programmed to allow for new PLU name programming during registration, you will be presented with the chance to enter a name for the PLU you are creating. Alternatively, the PLU will inherit the name of the department that it is linked to.

Subtotal again once you are finished. The cash register will thereafter store the new PLU for future transactions.

Example: Creation of PLU 123, Cola, with a price of \$1.50, linked to Department 3 with PLU programming active.

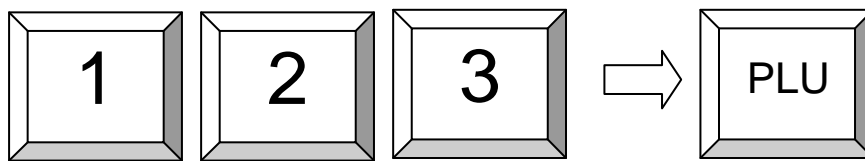

...then the display will prompt you to create, if PLU is not programmed.

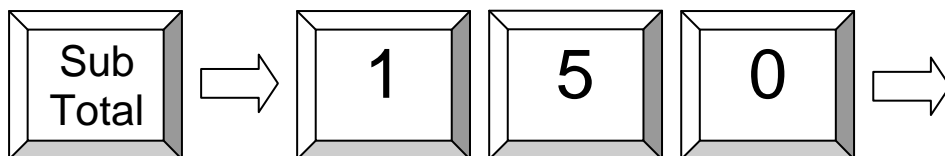

Enter the price...

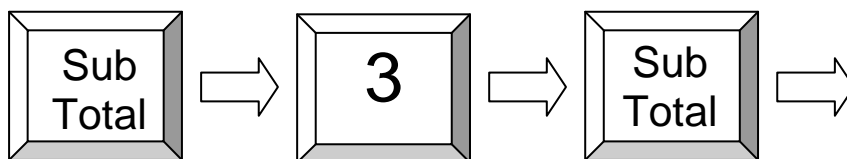

Enter the Department to be linked to...

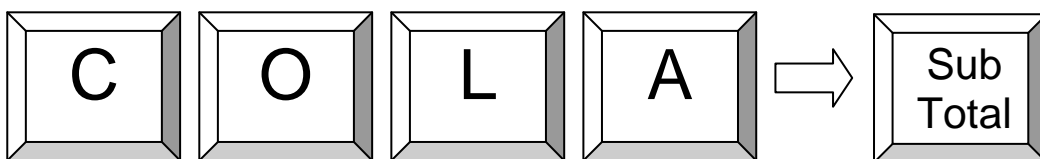

And finally the PLU name

Note: The name of the PLU has to be entered using the Letter Keys on your Keyboard

2.4 Ringing up Multiple items in a Sale

Instead of pressing the same item repeatedly, the salesperson can make use of the Multiplication Key. Enter the quantity first to be rung up, followed then by the Multiplication Key and then the item.

Example: To ring up an open department of \$3.50 five times.

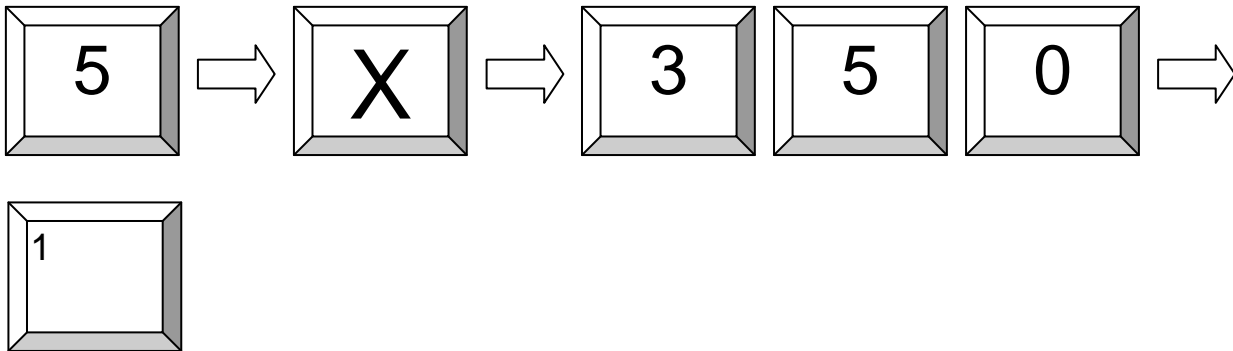

Example: To ring up a preset PLU 25 not programmed on the keyboard 3 times.

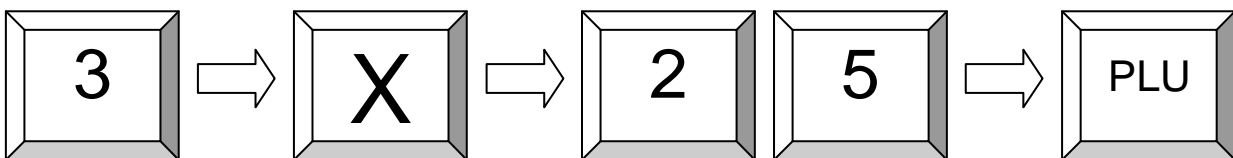

Example: To ring up a PLU with a barcode 60050779 three times.

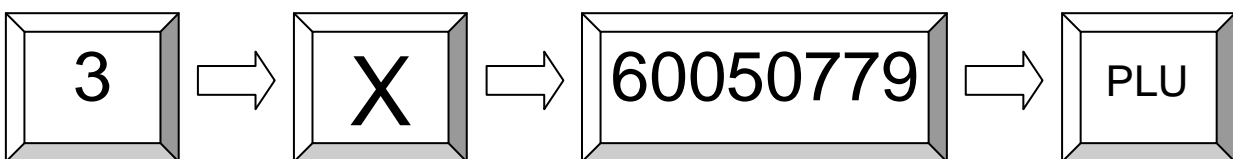

Note: the bar code digits must be entered individually with the Number Keys.

2.5 Tendering a Sale

A sale has to be tendered for it to be valid. Several tendering keys may exist on the keyboard. The most common are CASH, CARD, and CHECK. Other tendering keys may be added to the keyboard. See Programming Tender Keys in the Programming Manual.

Example: To complete a cash sale, first press the Subtotal Key. Then enter the amount received, such as \$10 from the customer, and press CASH. The display will then show the change that the customer will receive

Your Store		
2 Cola	2,20	4,40

2 Total		4,40
Cash		10,00
Change		5,60

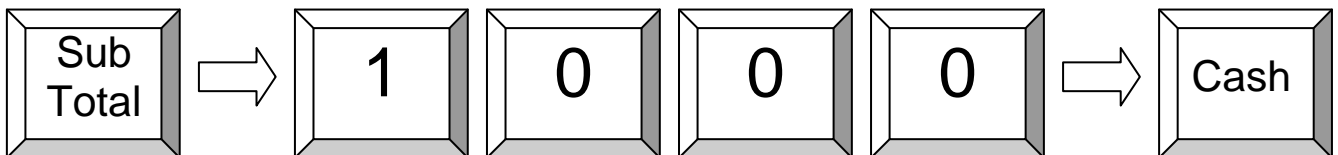

To complete a credit card transaction, simply press the Tender Key CARD. The cash register will assume the Subtotal amount as the amount being tendered

3. Voiding and Negative Transactions

3.1 Clearing a Numeric Entry

To erase an incorrect entry not yet registered, press the Clear key, normally located on the bottom left of the keyboard

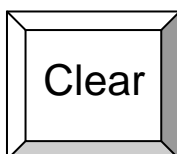

3.2 Correcting the Last Entry

The Error Correct Key (EC) is responsible for voiding the last item that the user rang up in a sale. This is normally the item that appears on the display. An error correct can only be used in a sale and can only void the last item. To void other items, refer to Voiding Items during a Sale.

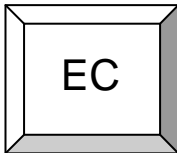

Your Store		
2 Cola	2,20	4,40
Error Correction		
2 Cola	-2,20	-4,40

Total		0,00

3.3 Voiding Items during a Sale

Voiding refers to the removal of certain items from a sale, usually because of an incorrect entry. The majority of users have their cash registers programmed in such a way that only the managers are able to correct such entries. Managers have to physically enter a key into the control lock and turn it to the (M)anager position before any voids can be done (See Chapter 1.3). This also includes any other negative transactions, such as discounts and pay-outs.

To void an item in the R position of the lock while under manager supervision, press the Void Key first and then the item to be voided.

Your Store		
2 Dept1	2,50	5,00
Void Item		
1 Dept1	-2,50	-2,50

1 Total		2,50
Cash		2,50

Example: To void department 1 with an amount of \$2.50.

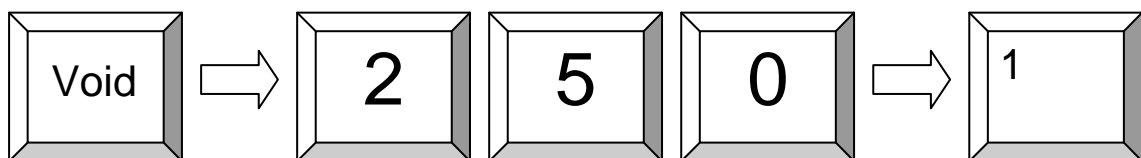

Example: To void a PLU with a barcode 60050779.

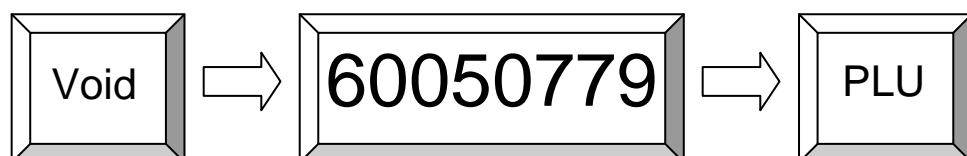

To void an item under the managers supervision first turn the key lock to the (M)anager position. Then proceed with the void as explained above.

Example: To void a scanned PLU.

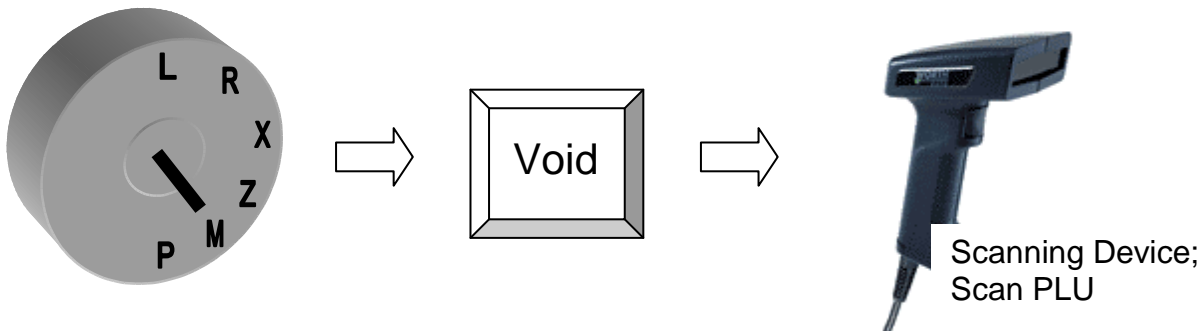

Once the item has been voided, turn the key back to the (R)egister position and proceed with the sale.

3.4 Refunding Items outside of a Sale

When items are being returned, a refund must be done on the cash register to record the item back into stock and refund the customer with some form of payment.

To refund an item, press the Refund Key/Return Key and then the item to be returned. Remember to press the Refund Key before each item, if more than one item is being returned.

Your Store		
Refund		
1 PLU 5	2,50	-2,50
Refund		
1 PLU 8	4,00	-4,00

2 Total		-6,50
Cash		-6,50

Example: To cash refund PLU 5 and PLU 8.

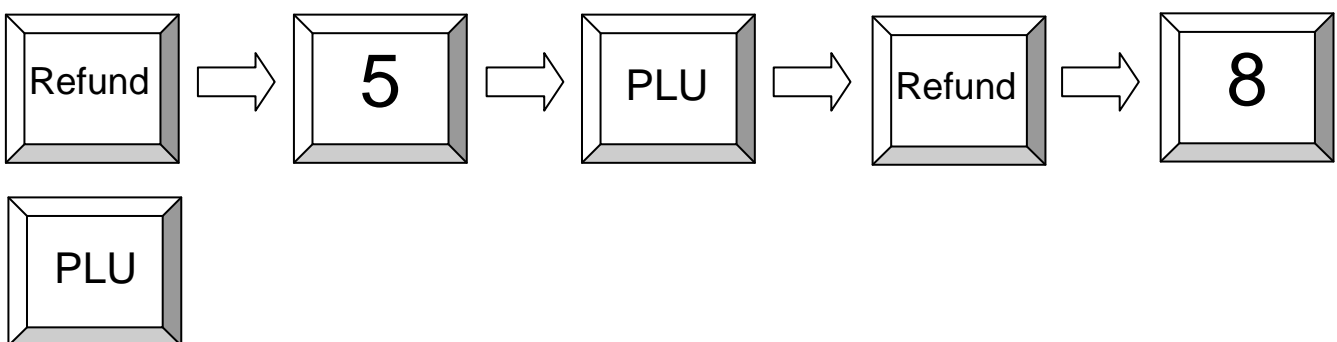

Example: To refund a scanned item where manager supervision is required.

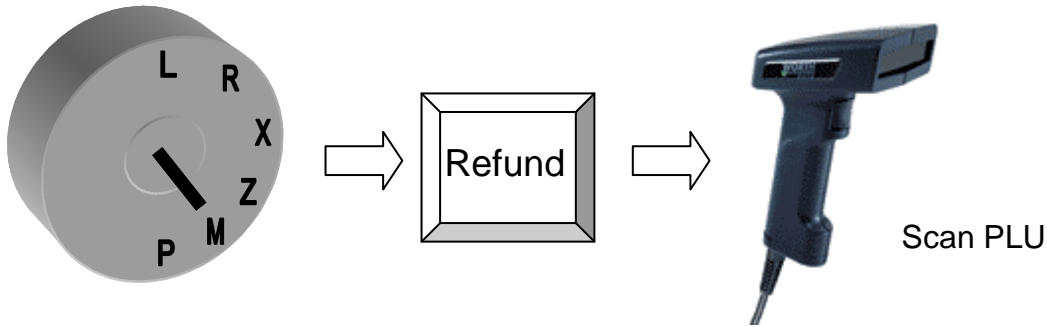

If an item is being swapped out or exchanged, refund the returned item first, then register the new item. Press Subtotal to view the outstanding amount due.

Example: The customer is exchanging PLU 1 with PLU 2.

Your Store		
Refund		
1 PLU 1	2,50	-2,50
1 PLU 2	4,00	4,00

Total		1,50
Cash		1,50

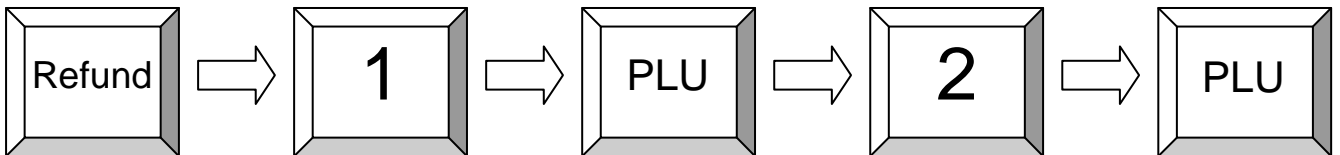

3.5 Giving Discounts during a Sale

Two forms of discount exist, namely percentage discount and amount discount. This can be further divided into net discount per item and gross discount per total sale. You can also preset or determine how much discount to give for any given sale.

To give a discount for a single item, enter the item first, then enter the discount amount or percentage and press the Discount Key.

If a discount has already been pre-programmed on the cash register, you only need to press the Discount Key. To give a discount for the entire sale, press the Subtotal Key first. Next, enter the discount percentage or amount, followed by the Discount Key. Press Subtotal again to view the new Subtotal amount.

Your Store		
5 PLU 1	2,00	10,00
Disc 10%		1,00

5 Total		9,00
Cash		9,00

Example: Percentage Discount on PLU 7 where the discount is pre-programmed.

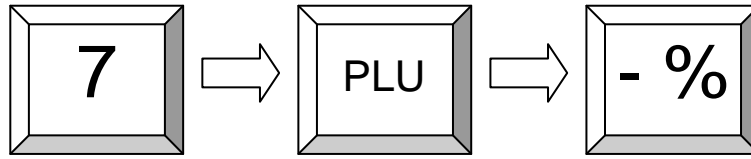

Example: Percentage Discount on the entire sale, where the user must determine the percentage to be given (10%).

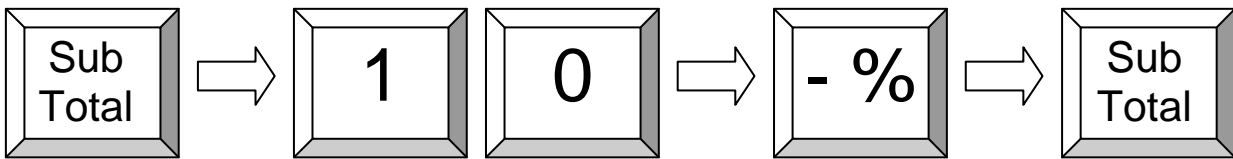

Discounts...

Example: Pre-programmed Amount Discount on a scanned PLU, where the manager supervision is required.

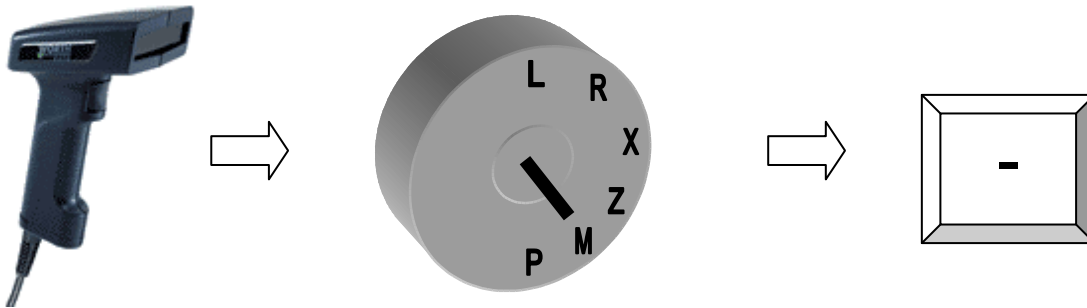

Note: Surcharges (+%) are carried out in the same sequence as above

3.6 Cancellation of a Sale

To cancel an entire sale, simply press the Cancel Key. The cash register will cancel all items that were rung up for that particular sale. Under manager supervision, turn the control lock to the (M)anager position and press the Cancel Key.

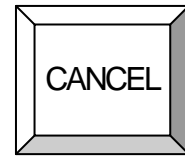

3.7 Voiding a Complete Sale

Voiding a complete sale performs the same function as a refund, in that items are being returned back in stock. The only difference between a transaction void and a refund is that in a refund, the Refund key must be pressed before each item. With transaction void, you need only press the key once, then the cash register remains in a negative mode until the transaction has been tendered.

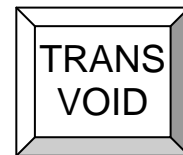

To carry out a transaction void, press the Transaction Void key first, then enter all the articles to be voided out, and complete the sale with a payment key.

4. Advanced Sales Functions

4.1 Department Shifts

It is possible to have more than one department on the same key. This procedure, known as department shifts, allows the user to fit more departments onto the keyboard. The default shift is always Shift 1. To access Shift 2, simply press the Dept. Shift Key. The cash register will automatically return to Shift 1, or will remain on Shift 2 until the user changes the shift, depending on the flag set-up of the cash register (See programming manual).

4.2 PLU Price Shifts

The cash register allows for more than one selling price for each PLU. This is a useful function for special occasions, such as Happy Hour or item promotions. An automatic price shift can be programmed into the cash register or the user can manually change the price shift. The way in which the cash register is programmed will determine whether the price shift changes after:

- a) each PLU
- b) each Sale
- c) remains on the same price level until manually changed

Example: To register PLU 5 with Price Level 2.

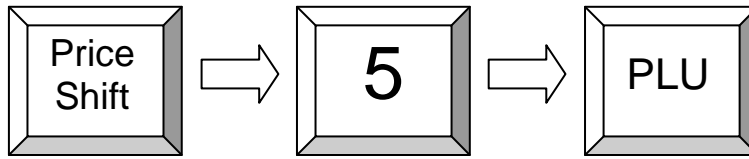

To return to Price Level 1, simply press the Price Shift Key again.

4.3 Foreign Currency Function

Foreign currency conversion is important for those countries that deal with more than one currency.

Example: If a sale was to be paid with a foreign currency that was programmed in the cash register, the user would first press the Subtotal Key followed by the appropriate Foreign Currency Key. The display will show the amount due in the foreign currency. After the amount has been tendered, the display will show the change due in the local currency.

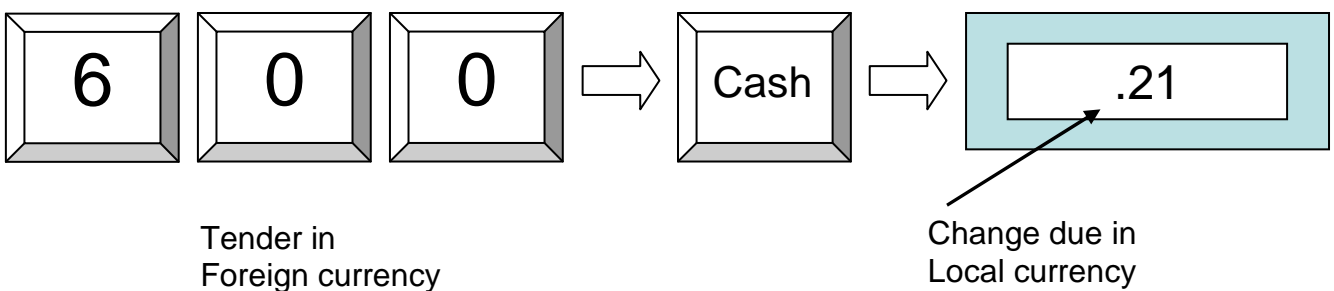
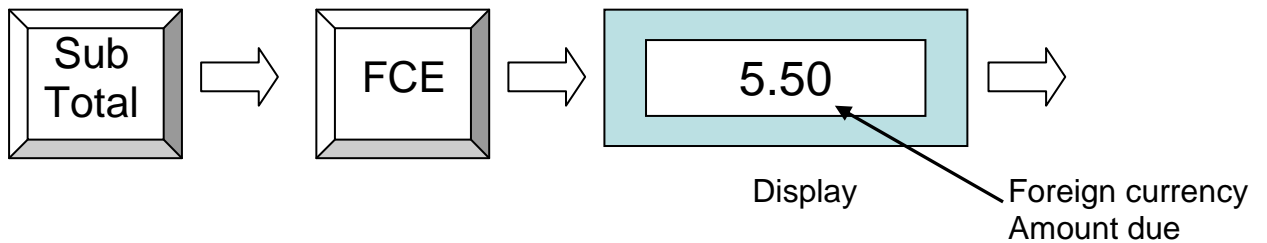

4.4 Holding a cash Sale

The hold function allows the user to temporarily hold a sale, proceed to the next sale, and later call up and complete the original sale. This is useful in situations, where there are complications experienced by the purchaser, such as an article with no price, or where the purchaser does not have enough money, and holding the sale helps reduce time wasted at the counter. To hold a sale, simply press the Hold Key. To recall the sale, press the Hold Key again. Complete the sale and proceed with the next customer.

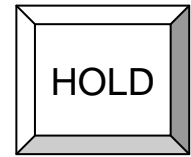

Note: make sure there are sales on hold before attempting to take Z-Reports. In such situations an error will occur. Tender all sales on hold before taking the report.

4.5 Receipt On/Off & Duplicate Receipt

If a receipt does not have to be produced, you can switch off the receipt printer by pressing the Receipt On/OFF Key. To reactivate the printer, simply press the Receipt On/OFF Key again.

In cases where a receipt is required and the receipt printer has been switched off, the user can print a 2nd receipt. By pressing the Subtotal Key after a sale, the printer will produce a copy of the sale. Receipts can only be reprinted for the last sale.

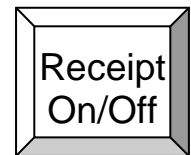

4.6 Time and Date Functions

You can view the current time on the cash register by pressing the Multiplication Key while the control lock is in the (R)egister position. To reset the time and date, refer to the Programming Time and Date Functions in the Programming Manual.

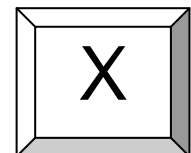

4.7 No Sale Function

The No Sale function allows the user to open the cash drawer without registering a sale. You can view the number of times a No Sale function has been carried out in the X/Z reports. The No Sale Key can also be used as a reference key. To print a specific reference number on a receipt, enter the reference number and press the No Sale Key.

Example: To print a reference number 123 on the receipt.

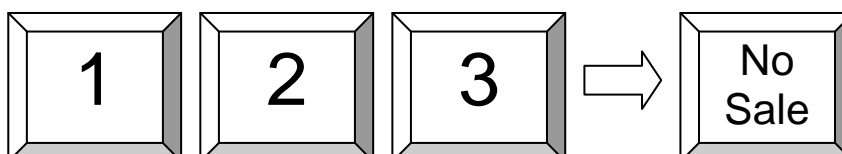

4.8 Pay-Out and Received on Account

Money can be paid out of the cash drawer for special purposes, such as petty cash, etc. This is referred to as a Pay-Out (PO). To perform a pay-out, firstly enter the amount to be paid out, then press the Pay-Out Key (PO) and finally a Tender Key, i.e. CASH, CARD or Check. The accumulated PO total will appear in the financial reports.

Your Store	
Pay Out	25,00

Total	25,00
PO-Cash	25,00

Example: To make a \$25 cash pay-out.

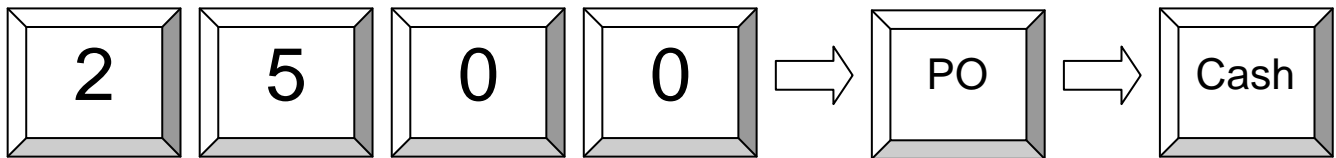

Conversely, money can also be received into the cash drawer. This transaction is known as Received on Account (RA). Adding more float to the cash drawer would be one example of Received on Account. To perform a RA transaction, first enter the amount received, then press the RA Key, and finally a Tender Key (CASH, CARD, or CHECK, etc). The accumulated RA total will appear in the financial report.

Example: To receive an amount of \$50 cash.

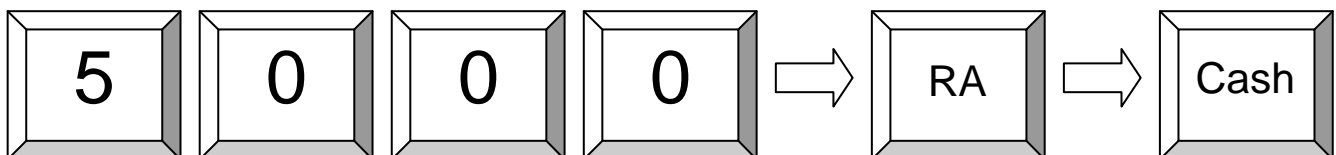

4.9 Split Tendering Function

Depending upon whether the cash register allows for it, Split Tendering allows the operator to use more than one tender to close off a sale. This function is used when, for instance, half a sale is closed off in cash and the other half to a card.

Example: A subtotal of \$10, of which \$6 is paid in Cash and \$4 is paid by Card.

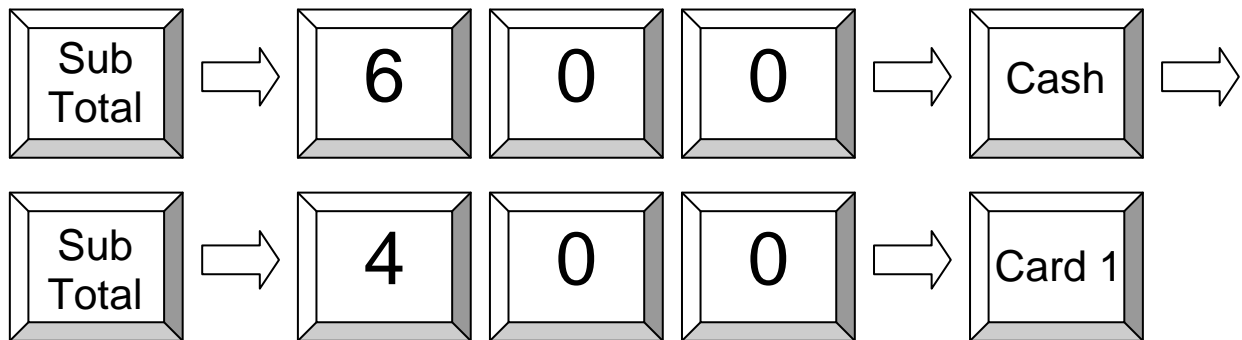

Note: make sure that the entire total has been tendered before proceeding with the next sale.

4.10 Preset Price Override Function

In certain situations the user is required to override a preset price during a sales transaction. For this option to function, a PLU Ent Key must be programmed on the keyboard (See Programming Manual).

Example: To override the price for PLU 5 with a new price of 50c.

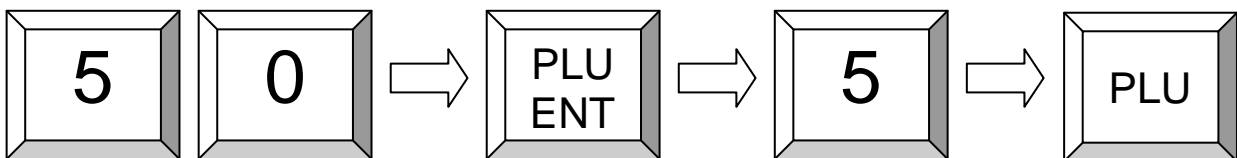

5. Hospitality Functions

5.1 Assigning a Waiter

See Chapter 2.1 Signing on a Clerk.

5.2 Opening a New/Existing Table

In order for the cash register to store a client's order, the waiter must assign a table number. The cash register will store all articles entered for that specific person until the table has been paid. There are 2 ways to open a table.

Option1: Entering the table number and pressing Table #

Example: To open Table 5

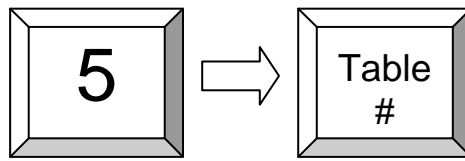

Option2: By pressing Table #, scrolling down until the table has been found, and pressing Table # again to make the selection.

Example:

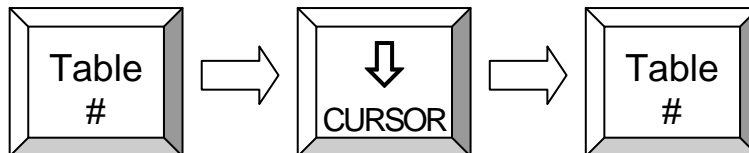

Once a table has been opened, the user can begin entering the articles. Modifiers may also be programmed on the keyboard and can also be entered at this time. A modifier is an instruction to the kitchen as to how the food is to be prepared. Medium rare and sunny-side-up are 2 examples of modifiers. Since modifiers are registered by number, there are 2 methods of entering. Enter the number of the modifier and press the Modifier key, or press the Modifier Key and scroll down until the modifier has been found, and then repress the Modifier Key to make the selection from the display.

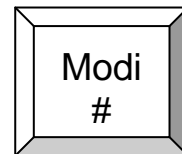

When the order has been entered, press the Table # Key. The order will now be printed out at any available kitchen printers, and the client's balance will be updated. Follow this procedure for all orders that need to be entered in the cash register.

5.3 Printing the Bill and Closing off the Table

The default setting of the cash register is such that 2 bills need to be printed out for each client. If your set-up is otherwise, please consult your dealer for assistance.

The first bill that is printed out is referred to as the *Statement*. This can be printed at any time during the table transaction and produces a consolidated summary of all the items for the table. This printout is performed when the client requests the bill. To print this *Statement*, open the table, press the Print Table Key, followed by the Table# Key. The bill is clearly marked "NO INVOICE", since this is just a Statement. You can still enter additional orders thereafter.

Example: To print the bill for Table 2 (*Statement*).

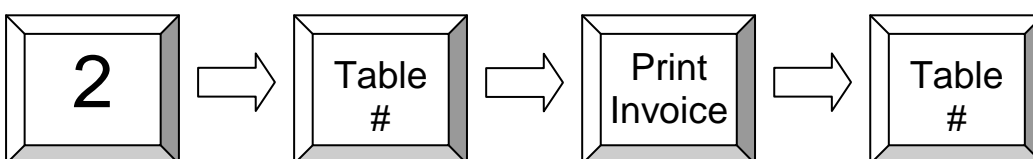

Once the bill has been paid by the client, the waiter can close-off the table and print a valid invoice for the client. To achieve this, enter the table number followed by the Print Table Key. The waiter is now required to choose a form of payment, i.e. CASH, CARD, CHECK. When a Payment Key has been pressed, the bill will be printed. The printed bill includes the "INVOICE" header as well as all the articles ordered and the payment form.

Example: To close-off and print a valid invoice for Table 7.

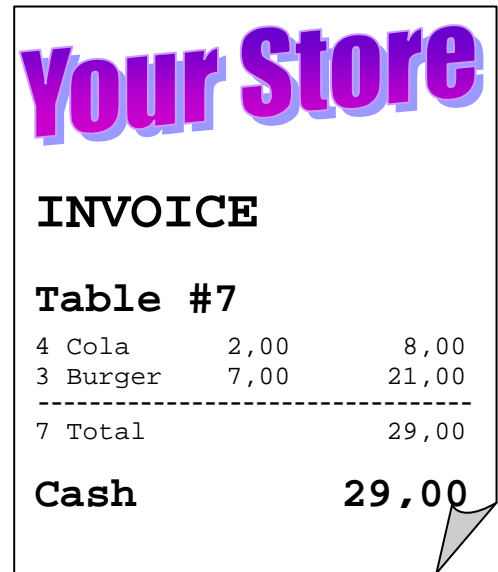
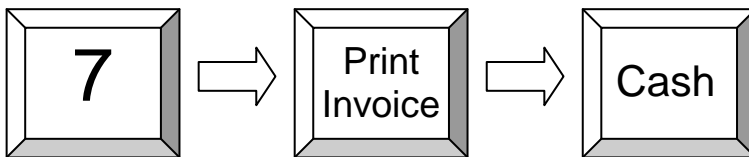

6. Advanced Table Functions

6.1 Voiding an Item in a Table

Voiding items in a table can be achieved as explained in Chapter 3.3 **Voiding items during a Sale**. Another way to void an item is by accessing the table , scrolling until the article has been found, and then pressing the Void key.

Example: To void an item from table 1 using the scrolling keys

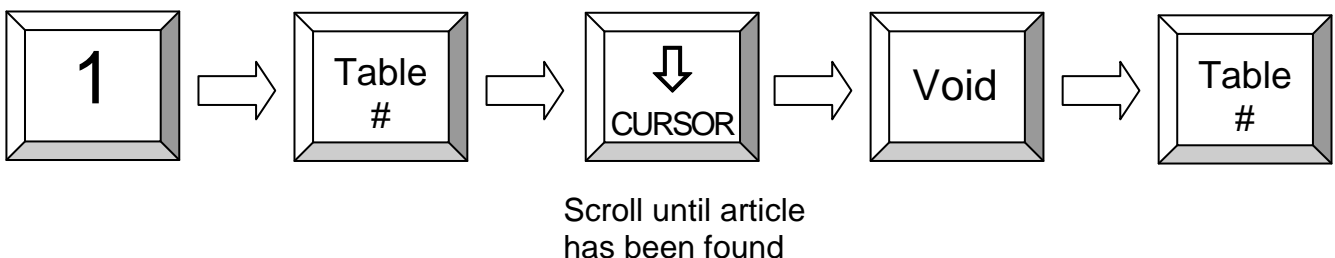

6.2 Transferring Tables

Transferring tables allows the user to transfer all items registered on one table to another. However, the table being transferred to must have a balance of zero.

To transfer a table, open the existing table, press the Table Transfer Key, enter the table to be transferred to, and then press the Table # Key.

Example: Transferring table 1 to table 3.

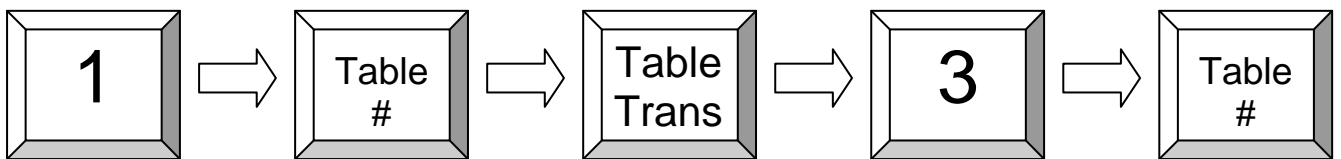

6.3 Splitting a Table

On certain occasions it may become necessary to split a table bill into separate portions. In such a case, the user must simply open the table balance and then press the Split Table key. The cash register will now show the items on the table. Select an item and press the Split Key again to confirm your choice. Upon completion close the transaction with a print table or tender key.

Example: To split table 2

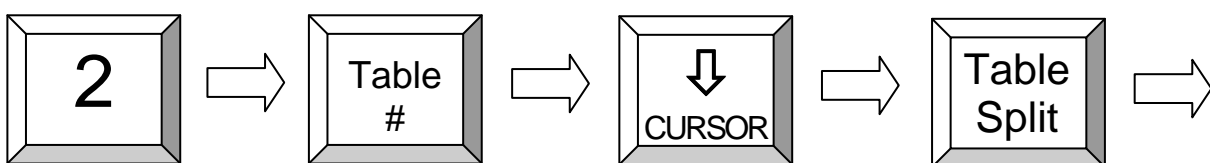

Scroll until article
has been found

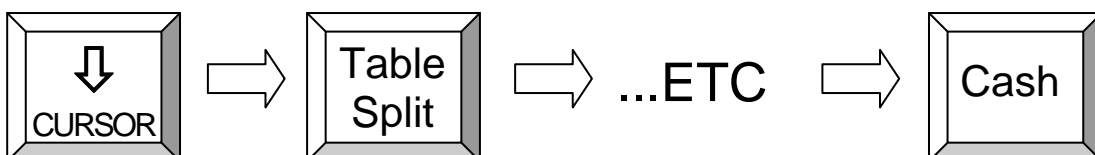

Scroll until article
has been found

6.4 Using Condiments

CONFIGURING THE SYSTEM USING QPROG

Before you can use condiment selection you must activate the condiment table file and condiment selection option in the configuration of the application program. As an example the system will be setup for maximum 16 condiment tables selection on PLU level. PLU # 1 will be programmed as STEAK and for compulsory selection of Condiment Table# 1 and 2. Table# 1 will be used for prompting RAW, MEDIUM, WELL DONE and Table# 2 will be used for FRENCH FRIES, BOILED POTATOES, BAKED POTATOES. This example can be used on a 2 line or 8 line display the only difference is the number of condiments shown on the display. Note that on the 2 line display the Condiment Table name is not shown.

1 – CONFIGURE CONDIMENT TABLES FILE

- Open: QPROG->CONFIG->CONDIMENT TABLE
- Set number of condiment tables to 16. (The maximum number which can be used for prompting is 32).
- Set the name length to 16 (This name is shown on the display when the table is displayed).
- Set number of condiments in a table to 7 (On the multiline display maximum 7 condiments are displayed in one screen but it is possible to use more then 1 screen).
- Confirm by pressing OK

2 – CONFIGURE PLU FILE FOR CONDIMENT PROMPTING

- Open: QPROG->CONFIG->PLU FILE
- Set Condiment Selection to 16. (The max. number of tables for prompting is 32).
- Confirm by pressing OK

3 – CONFIGURE MODIFIER FILE

- Open: QPROG->CONFIG->MODIFIER FILE
- Set the number of Modifiers to 50.
- Set the name length to 16.
- Confirm by pressing OK

4 – PROGRAM MODIFIERS USED IN CONDIMENT TABLES

- Open: QPROG->FILES->MODIFIERS
- Program Modifier# 1: RAW
- Program Modifier# 2: MEDIUM
- Program Modifier# 3: WELL DONE
- Program Modifier# 11: FRENCH FRIES
- Program Modifier# 12: BOILED POTATOES
- Program Modifier# 13: BAKED POTATOES

5 – PROGRAM CONDIMENT TABLE# 1 and 2

- Open: QPROG->FILES->CONDIMENT TABLES
- Select Condiment Table# 1
- Enter Name PREPARATION
- Set OPTION 1-1, Compulsory Selection
- Click on LIST Column
- Enter Key code 4001, 4002 and 4003 for Modifier 1, 2 and 3.
- Select Condiment Table# 2
- Enter Name POTATOES

- Set OPTION 1-1, Compulsory Selection
- Click on LIST Column
- Enter Key code 4011, 4012 and 4013 for Modifier 11, 12 and 13.
- Confirm by pressing OK

6 – PROGRAM PLU# 1

- Open: QPROG->FILES->PLU
- Select PLU# 1
- Enter Name STEAK
- Enter Department 1
- Enter Price 100
- Click on Column CONDI 1-8
- Select 1 and 2

7 – INSTALL PROGRAM IN CASH REGISTER

- For testing you could use Kitchen Printer# 1 programmed on the Internal Printer.
- Activate KP selection in the Department Configuration.
- Select Kitchen Printer 1 for Department# 1
- Program SYSTEM PARAMETER 21 to 2 and PARAMETER 22 to 0.

MAKING A SALE OF PLU# 1 (STEAK) WITHOUT QUANTITY ENTRY

1. Enter 1 on the PLU# key or press DIRECT PLU# 1
2. The register will display CONDIMENT TABLE# 1
3. Make a selection (2 for MEDIUM)
4. The register will display CONDIMENT TABLE# 2
5. Make a selection (1 for FRENCH FRIES)
6. Press CASH
7. The register will now finish the ticket and print the KP ticket with the selected condiments

MAKING A SALE OF 3 x PLU# 1 (STEAK)

1. Enter 3 on the MULTIPLY key
2. Enter 1 on the PLU# key or press DIRECT PLU# 1
3. The register will now show CONDIMENT TABLE# 1
4. Make a selection (2 for MEDIUM)
5. The register will show the selection on the operator display and ask for the quantity.
6. Press the MULTIPLY key without Entry to Confirm 3 times MEDIUM
7. The register will display CONDIMENT TABLE# 2
8. Make a selection (1 for FRENCH FRIES)
9. The register will show the selection on the operator display and ask for the quantity.
10. Enter 1 on the MULTIPLY key to select ONE FRENCH FRIES
11. The register will now re-display CONDIMENT TABLE# 2
12. Repeat steps 8 – 10 to select the other condiments.
13. Press CASH
14. The register will now finish the ticket and print the KP ticket with the selected condiments

Notes When a condiment table is set for no compulsory selection you can abort by pressing the CLEAR key and the register will continue with the next condiment table.

6.5 Additional Balance Functions

Select Balance Number



Balance Sales with Balance# key

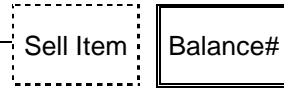

Balance Sales with Clerk Lock

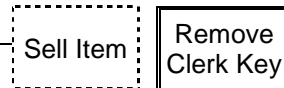

Subtotal Invoice (when allowed)

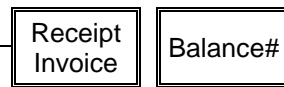

Subtotal Invoice directly after Sales

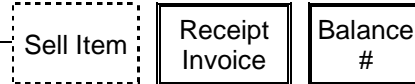

Invoice and Payment

Receipt or Slip, with or without
Endorsement message as programmed



Invoice and Payment directly after Sales

Receipt or Slip, with or without
Endorsement message as programmed



Invoice and Payment in Currency

Receipt or Slip, with or without
Endorsement message as programmed

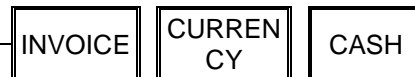

Transfer to Other Balance

To balance 5

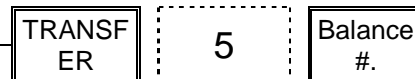

Split Items

1 Item is split

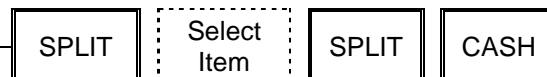

Split Items to other Balance

1 Item is split



Split Items with quantity entry

6 out of 10 beer should be split

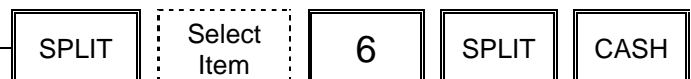

Select Balance Number

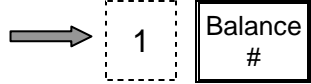

Sales with automatic Closing of Balance



Transaction Void during Balance Sales



Balance Subtotal Discount

Subtotal or Itemizer Discount including Balance total



Balance Subtotal Inquiry

Display subtotal including balance

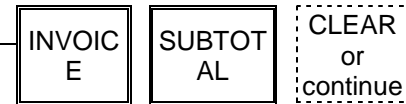

Balance Currency Subtotal Inquiry

Display currency including balance

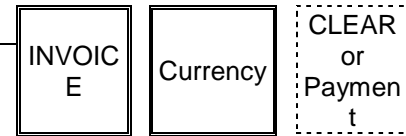

7. Programming the Cash Register

7.1 Programming the Date and Time

Programming the Date and Time can be easily achieved in the programming position. First, turn the register to the (P)rogramming position.

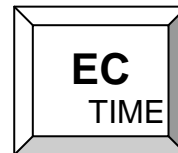

To enter the date, enter the following format :
DayDayMonthMonthYearYearYearYear (standard) or
MonthMonthDayDayYearYearYearYear

Then press the Date key. This key is normally two keys above the Clear key ie. EC or Void

To enter the time, enter the following format :
HourHourMinuteMinute (military time)

Then press the Time key.

This key is normally above the Clear key ie. EC or Void

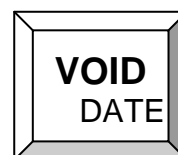

7.2 Easy Programming

The register has a special program mode which can be used by a clerk with Manager authority or when the Central Lock is in the MANAGER (M) position. The mode is started by entering the mode number on the SUBTOTAL key. When the mode is not active ERROR#1 (Invalid Entry) is shown otherwise the register will print the mode on the receipt, journal and electronic journal.

When the register is in Easy Programming Mode you can only exit this mode by either turning the Central Lock, remove the Clerk Key or by pressing the SUBTOTAL key without entry.

In mode 1, 2, 3 or 4 you must:

- 1 - Enter the new data
- 2 - Press SUBTOTAL
- 3 - Press a direct PLU key or enter the number on the PLU# key.
- 4 - Continue with next entry or exit by pressing SUBTOTAL without entry.

MODE 1

In this mode you can program the Plu Prices. The price of the active level is programmed. When you want to program a price of another level (when active) you must select the level first.

MODE 2

In this mode you can program the Plu Cost Prices.

MODE 3

In this mode you can program the first Plu Descriptor.

MODE 4

In this mode you can program the second Plu Descriptor.

MODE 5

In this mode you can program the Plu Department Selection.

MODE 6

In this mode you can add inventory to the PLU Inventory total when active.

MODE 7

In this mode you can subtract inventory from the PLU Inventory total when active.

MODE 8

In this mode you can change the Minimum PLU Inventory Level when active.

MODE 100, 101, 102 and 103

These modes are used for PLU file maintenance when Scanning Codes are used.

7.3 Programming Files

Programming the individual files using the keyboard is done by using the UP, DOWN, PGUP, PGDN, TYPE (program type), X and CR (User Report) key.

You can only program when the Central Lock is in X, Z or T position. You start programming by either entering the FILE# directly on the TYPE key or by pressing the TYPE key without entry which will open the programming window and you can select the file you want to program. Files which are not active in the configuration of the application will not be shown. At the end of the line the File# number is also shown for reference.

When the file has been selected the first record will automatically be displayed. You can select another record by entering the record number on the X key or by pressing the X without entry which will select the next record. The field you want to program can be selected by using the UP, DOWN, PGUP or PGDN keys. When the field is selected you can enter the new data and then press the CR (also User Report) key. When a field is modified it is printed on the Receipt, Journal and Electronic Journal.

When the register is in Programming Mode you can only exit this mode by either turning the Central Lock, remove the Clerk Key or by pressing the TYPE key without entry.

Please refer to the WQPROG.DOC manual for further explanation of the fields in the individual files.

Programming Mode 100, 101, 102, 103 and 255 are used for PLU file maintenance when scanning is used.

File Number	File Type	KeyCode	QPROG.DOC Chapter	QPROG.DOC Paragraph
1	Parameters	Not Available	Chapter 6 (SYSTEM)	System Parameters
2	Options	Not Available	Chapter 6 (SYSTEM)	System Options
3	Time zone	Not Available	Chapter 6 (SYSTEM)	Time Zones
4	Day of Week zone	Not Available	Chapter 6 (SYSTEM)	Day of the Week Zones
5	Day of Month zone	Not Available	Chapter 6 (SYSTEM)	Day of the MonthZones
6	Date Zone	Not Available	Chapter 6 (SYSTEM)	Date to Date Zones

File Number	File Type	KeyCode	QPROG.DOC Chapter	QPROG.DOC Paragraph
7	Receipt Header	Not Available	Chapter 6 (SYSTEM)	Receipt Header
8	Receipt Trailer	Not Available	Chapter 6 (SYSTEM)	Receipt Trailer
9	Slip Header	Not Available	Chapter 6 (SYSTEM)	Slip Header
10	Slip Trailer	Not Available	Chapter 6 (SYSTEM)	Slip Trailer
11	General Texts	Not Available	Chapter 6 (SYSTEM)	Fixed Texts
12	Error Messages	Not Available	Chapter 6 (SYSTEM)	Fixed Texts
13	General Messages	Not Available	Chapter 6 (SYSTEM)	Fixed Texts
14	Day Descriptors	Not Available	Chapter 6 (SYSTEM)	Fixed Texts
15	Month Descriptors	Not Available	Chapter 6 (SYSTEM)	Fixed Texts
16	Counters (X, Z, Invoice# Receipt#)	Not Available		
17	Total Sales	Not Available	Chapter 5 (FILES)	Total Sales File
18	Group	Not Available	Chapter 5 (FILES)	Group File
19	Departments	5XXX	Chapter 5 (FILES)	Department File
20	PLU	1XXXX – 5XXXX	Chapter 5 (FILES)	PLU File
21	Tax	Not Available	Chapter 5 (FILES)	Tax File
22	Clerk	2XXX	Chapter 5 (FILES)	Clerk File
23	Salesperson	3XXX	Chapter 5 (FILES)	Salesperson File
24	Tenders	7XX	Chapter 5 (FILES)	Tender File
25	Drawers	8XX	Chapter 5 (FILES)	Drawer File
26	PORA	9XX	Chapter 5 (FILES)	P.O. and R.A. File
27	Discounts	10XX	Chapter 5 (FILES)	Discount File
28	Corrections	11XX	Chapter 5 (FILES)	Correction File
29	Foreign Currencies	12XX	Chapter 5 (FILES)	Foreign Currency File
30	User Reports	Not Available	Chapter 5 (FILES)	User Report File
31	Balance Functions	13XX	Chapter 5 (FILES)	Balance Function File
32	Tables	Not Available	Chapter 5 (FILES)	Table Total File
33	Rooms	Not Available	Chapter 5 (FILES)	Room Total File
34	Accounts	Not Available	Chapter 5 (FILES)	Account Total File
35	NOT USED!!			
36	Modifiers	4XXX	Chapter 5 (FILES)	Modifier File
38	Endorsement Messages	Not Available	Chapter 5 (FILES)	Endorsement Message File
39	Keyboards	Not Available	Chapter 5 (FILES)	Keyboard Level File
40	Macro's	15XX	Chapter 5 (FILES)	Macro File
41	(Menu's (not yet implemented)	6XX	Chapter 5 (FILES)	Menu File
42	Price Levels	3XX	Chapter 5 (FILES)	Price Level File
43	Transaction Types (not yet implemented)	4XX	Chapter 5 (FILES)	Transaction Type File
44	Special Itemizers	Not Available	Chapter 5 (FILES)	Special Itemizer File
45	Window Lookups	16XX	Chapter 5 (FILES)	Window Lookup File
46	Condiments	14XX	Chapter 5 (FILES)	Condiment Table File
47	Action tables	Not Available	Chapter 5 (FILES)	Action Table File

7.4 Scanning

When scanning codes are activated in the configuration of the application it is possible to create and/or delete items on the cash-register either in Program Mode or during transaction when an item is not found. Furthermore there are some special maintenance procedures which are can be activated in Manager or programming mode.

It is possible to connect two scanners to the register. You can activate them by programming parameter 56 & 57 also check option# 78 for check digit verification when scanning.

CREATING ITEMS in Transaction Mode

When Option#79 is set the register will prompt for creation of an article when not found. If you want to create it you must confirm by pressing the SUBTOTAL key or abort by pressing CLEAR (Note that you can press the CLEAR key at any stage to abort!!). The register will now prompt for:

- 1 - The PRICE which you must enter on the SUBTOTAL key
- 2 - The Department which you must enter on the SUBTOTAL key
- 3 - The Descriptor when Option# 80 is set which you must enter on the SUBTOTAL key
- 4 – Now the article is registered.

Note: From Release XX030605 on it is also possible to enter the PRICE directly on a fixed DEPARTMENT key instead of entering the price and department on the subtotal key.

CREATING ITEMS in Program Mode

When you are in Program Mode# 20 (PLU programming) you can scan the code or enter the code on the X key. When not found the register will ask you for creation which must be confirmed by pressing the CR (User Report) key.

DELETING ITEMS in Program Mode

When you are in Program Mode# 20 (PLU programming) can also delete codes. When you enter ZERO on the X key the register will ask you if you want to delete the current code which must be confirmed by pressing the CR (User Report) key. Note that the records are only marked for deletion so they will only free up their space after PLU FILE MAINTENANCE.

PLU FILE MAINTENANCE

When using scan codes the register uses internally an INDEX file which is sorted so the register can find a code very fast. Because the PLU file can grow very large (max 50000) when using scan codes the register will store the newly created articles in a separate UPDATE file which is located at the end of the PLU file. The maximum size of the UPDATE file is HALF of the FREE SPACE in the PLU file. When for example the free space is 100 you can create 50 new items before the register will give the message to re-index the file. After re-indexing the file the remaining free space is 50 so you can again create 25 new articles. You can continue until the free space is only 1 record.

Note that is important that the UPDATE file doesn't grow to large (over 1000 articles) because this will have effect on the speed of creating new articles.

For maintenance of the PLU file there are the following commands:

100 – MERGE and DELETE

This command will MERGE the UPDATE and the BASE FILE and DELETE the articles marked for deletion. This command can be used when new items are created and items were deleted.

101 – MERGE

This command will MERGE the UPDATE and the BASE FILE. This command can be used when only new items are created.

102 – DELETE

This command will DELETE the articles marked for deletion. This command can be used when items were only deleted.

103 – CHECK STATUS

This command will print and display the number of articles in the BASE and UPDATE file.

255 – CLEAR COMPLETE PLU FILE

This command will clear the complete PLU file. Note that PLU sales and inventory information is also cleared.

The command can be issued in programming mode on the TYPE key and in MANAGER mode on the SUBTOTAL key. Note that COMMAND 255 to clear to complete PLU file is only available in PROGRAM MODE.

PLU'S WITH SCANCODES ON KEYBOARD

When using scan codes it is also possible to put a PLU directly on the keyboard of the register. Because the key code as programmed in the key table contains the record number in the PLU Index file and not the scan code there are a few points you must keep in mind.

1 – PLU File Maintenance

Maintenance of the PLU file like creating and/or deleting PLU's should be done either on the computer OR on the register but NOT ON BOTH because this will result in different Index files for the computer and register.

2 – Programming PLU keys in WQPROG

When programming PLU keys in WQPROG you must enter the scan code in the code field.

3 – Programming PLU keys on the Register

When programming PLU keys on the register you must enter the scan code in the key-programming mode. The register will automatically insert the correct index record number in the key table. The register will recognize the entry as a scan code when MORE than 5 digits are entered. Normal key codes have a value of maximal 5 digits. This means that when you want the program a PLU with scan code "123" you MUST enter "000123". Suppose this PLU is located at record number 5 the register will put 10005 as key code which is also shown on the display. When you enter "123" the register will program key code "123".

USING PLU'S WITH SCANCODES IN COMBINATION WITH BALANCES

On the Balance the Index Number of the PLU is stored so at the moment it is NOT ALLOWED to create or delete PLU when there are still balances open because the sequence of the index file will be changed which will result in wrong PLU on invoices.

7.5 Programming Network Features

7.5.1 Activating the Network

The network is activated by programming the REGISTER# in PARAMETER 53 and the NETWORK PORT in PARAMETER 89. There are two types of network possible:

RS-232 NETWORK

When you want to connect only 2 registers in a network you can also use a RS-232 network using the standard RS-232 ports in your register. The NETWORK PORT for RS-232 can be any port except PORT# 4 which is fixed for the RS-485 network. The maximum BAUDRATE for PORT# 1, 3 & 4 is 57600 (PARAMETER 2, 4 or 5, value 6) and the maximum BAUDRATE for PORT# 2 is 9600 (PARAMETER 3 value 3 o. It is advised to use the highest possible baud rate.

RS-485 NETWORK

When you want to connect more then 2 registers in a network you MUST use a RS-485 network which means you also need an RS-485 card installed in your register. The NETWORK PORT for RS-485 is fixed to PORT# 4 and the maximum BAUDRATE is 57600 (PARAMETER 5, value 6). Other possible baud rates are 38400 (value 5), 19200 (value 4). It is advised to use the highest possible baud rate.

The network can be used only for communication with the PC.

7.6 Training Mode

Training mode allows for training on the cash register without registering what has been rung up. No reports will be affected by whatever has been rung up in Training Mode, and every receipt that is produced in training will be printed with a training message. A hash (#) will also appear on the left hand side of the display.

In order to access Training Mode, a pre-programmed training clerk must be activated. Training mode will remain activated until a new clerk is assigned. Training clerks can either be assigned in the (R)egister or the (P)rogramming position. Certain clerk flags permit the changing of training clerks in the P position only.

8. System Reports

All reports, whether x, z, or any financial, report are freely customizable and programmable by the user. Therefore, you will be able to include any information you consider essential. You can call up reports by turning the control lock key into the appropriate lock position, either X or Z. Upon positioning the key in the right location, the display will show a report type. You can now use the up/down keys to parse the list of reports on the display. Selection occurs when you enter the number of the report (shown to its right) followed by the Subtotal Key to confirm your choice.

Example: Printing Report #5 after having moved the control lock to the X or Z position. Use the Down Key to move down the list on the display until the report (5) is shown.

Option1: *Scrolling*

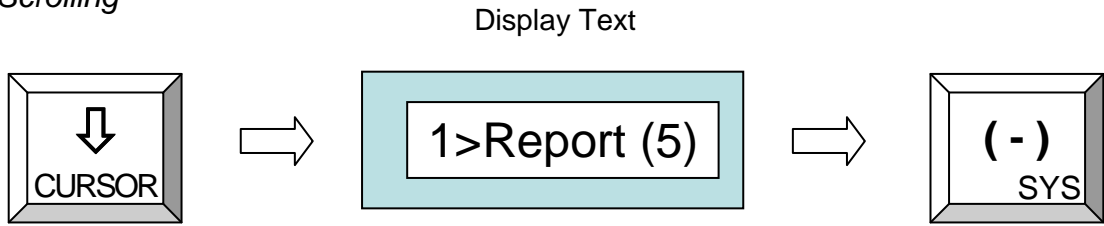

Option2: *Entering the Report Number Directly*

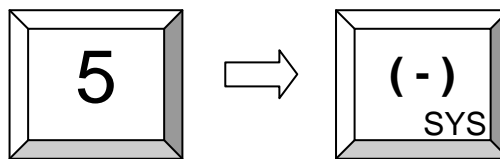

Note: *The X or Z position merely determines, if the information will remain in storage after print out. The Z-Report erases the printed data from memory, while the X-Report retains the data. By pressing the CASH Key instead of the SUBTOTAL Key one can also call up corresponding User Reports.*

8.1 User Report

As a user one can also compose specific reports that include several of the predefined reports. The type of reports that will appear can be set when programming the cash register (See Programming Manual). The user can then select this specific report by entering the User Report Number (also set when programming) followed by the Cash Key (CR).

Example: Assume the User Report is Report #5. CR usually corresponds with CASH.

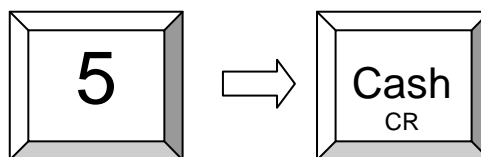

8.2 Types of System Reports

Key lock position X or P : Print without clearing data
 Key lock position Z : Print and clear data

xx + SYS (-) : Print system report type xx :

Report Type	ID
Total Sales	1
Groups	2
Departments	3
Articles	4
Tax Totals	5
Tendering	6
Drawer Total	7
P.O. & R.A.	8
Discounts	9
Correction	10
Foreign Currency	11
Balance Function	12
Table Total	13
Special Item	18
PLU Inventory	20

Please note the programming of the system keys. Default: SYS = COUPON

8.3 Printing the Electronic Journal

Key position X, Z or P :

- 101 + ENTER (CASH) : Print out last receipt
- xx + Multiplication (X) + 101 + ENTER : Print out last xx receipts
- 0 + Multiplication (X) + 101 + ENTER : Print out complete journal

Key position Z :

- 102 + ENTER (CASH) : Clear the Electronic Journal
- 0 + Multiplication (X) + 101 + ENTER : Print out and clear the complete journal

Please note the programming of the system keys! Default: ENTER = CASH

9. Installing the Cash Register

9.1 Dot Matrix Printer

9.1.1 Installing of Paper Rolls

Cut the edge
to be feed straight
like this



Do not try to feed
the paper if it is
like this

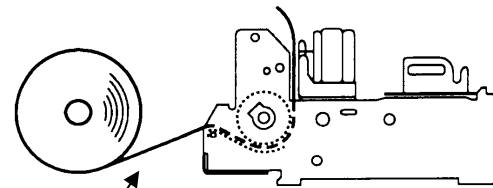
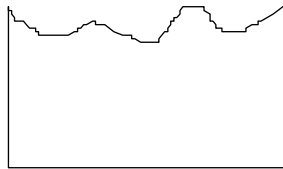

this way

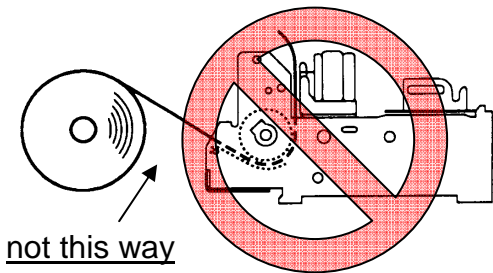

not this way

1. Lift up and remove the printer cover.
2. Load the paper rolls into their respective receptacles. The end of the paper roll must feed from below.
3. Feed the end of the paper roll into the paper entrance of the printer. Press and hold the "Journal Feed" key and feed enough paper so it can be inserted into the slot of the take-up reel. Wind two or three turns of paper around the reel.
4. Now feed the end of the receipt paper roll into the printer. Press and hold the "Receipt Feed" Key to pass the paper through the printer.
5. Feed the paper from below through the paper slot of the printer cover and reinstall the printer cover.

To remove a paper roll, cut as shown and feed out the off-cut with the respective "PAPER FEED" Key.

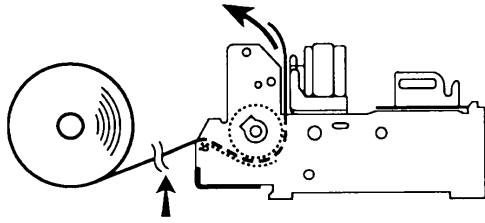

cut the paper here

Warning: Do not under any circumstance pull the paper while still printing. Printer may be damaged.

Repeat these steps for the second printer station when applicable.

9.1.2 Installing and Replacing of Ribbon Cassette

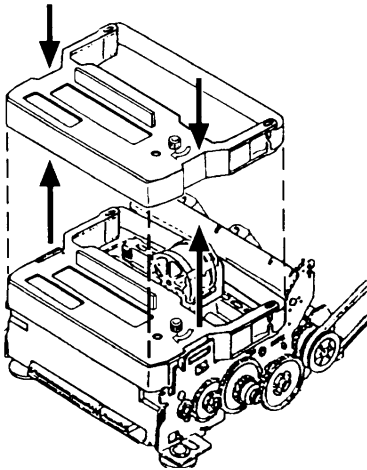

1. Lift up and remove the printer cover.
2. Fit the left side clip of the ribbon cassette into its receptacle of the cassette holder and press down on the cassette for a proper fit. To remove a used ribbon cassette push it to the left and lift it out.
3. Reinstall the printer cover.

9.2 Thermal printer

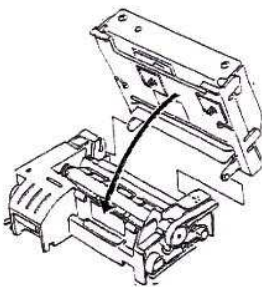

Cutter

Printer

9.2.1 Paper Insertion

1. Turn the Cash Register on.
2. Using scissors cut the edge of the paper roll as shown below.

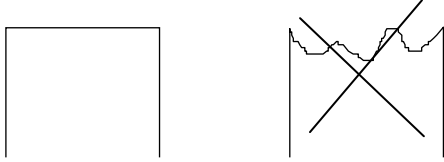

3. Open the printer cover.
4. Insert the paper roll with the correct direction.
- 5.

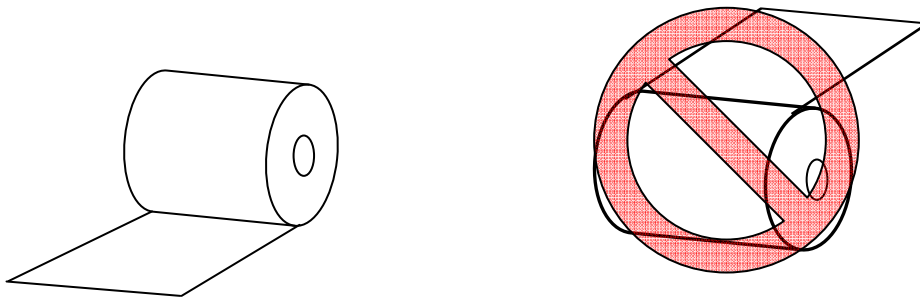

6. Hold both edges of the paper and insert it straight into the paper funnel. The printer feeds and cuts the paper off automatically.
7. Close the printer cover.

To remove the paper roll, follow the steps below:

1. Turn on the Cash Register and open the printer cover.
2. Cut the paper off between printer and paper roll.
3. Remove the paper roll from the bottom housing.
4. Press the "FEED" key to remove the remaining paper.

Note: Do not pull out the remaining paper in the opposite direction of the paper feed!

10. Accessories and Options

10.1 Ribbon Cassettes

Ribbon cassettes are available from your dealer. Please only use your original supplier.

10.2 Option PC Interface

A separate PC communication manual is provided if your Cash Register is equipped with a PC interface. 1 x RS232 is the standard configuration.

11. Maintenance

- Do not disassemble your Cash Register for cleaning purposes. For cleaning use a dry or slightly damp soft cloth. Never use water or volatile chemicals such as thinner, benzene or alcohol.
- Do not drop any metal objects such as paper clips into the Cash Register or printer as this may lead to shorts, damages or electrical shocks.

11.1 Information on the Electromagnetic Compatibility and Safety

CE Conformance

This QUORION cash register conforms to the European Community's EMV 2004/108 directive.

The cash register fulfills the following technical European requirements:

- EN 55022 – „Norm values and measuring procedures for radio interference properties – characteristics of information technology devices“
- EN 55024 – „Norm values and measuring procedures for the interference resistance properties– characteristics of information technology devices“
- EN 60950 – „Security measurements for the installation of IT“

A "conformance explanation" in accordance with the directives and standards cited on top has been delivered and can be reviewed with

QUORION Data Systems GmbH
An der Klinge 6
99195 Erfurt
(E-mail: rd@quorion.de; web: www.quorion.de)

REMARK: If the cash register is installed in a system with other devices and components, all other devices and components must each show EMV conformance to the norm. According to the EMV 2004/108 directive as well as EC and national laws, the system integrator is responsible to ensure that the built system complies with regulations

Power Cord Exchange

The power cord can only be exchanged by a certified technician. The same type of cord has to be used.

12. Character Code Charts

	0	1	2	3	4	5	6	7	8	9	A	B	C	D	E	F
2	Space	!	"	#	\$	%	&	'	()	*	+	,	-	.	/	
3	0	1	2	3	4	5	6	7	8	9	:	;	<	=	>	?
4	@	A	B	C	D	E	F	G	H	I	J	K	L	M	N	O
5	P	Q	R	S	T	U	V	W	X	Y	Z	[\]	^	_
6	`	a	b	c	d	e	f	g	h	i	j	k	l	m	n	o
7	p	q	r	s	t	u	v	w	x	y	z	{		}	~	?
8	€		,		„	...	†	‡		‰	Š	<	Ś	Ť	Ž	Ž
9		‘	’	“	”	•	–	—	~	™	š	>	ś	ť	ž	ž
A		˘	˘	Ł	ł	Ą	;	§	¨	©	Ş	«	¬	-	®	Ž
B	°	±	˙	ł	´	µ	¶	·	˙	ą	ş	»	Ł	˘	ł	ż
C	Ř	Á	Â	Ã	Ä	Í	Ć	Ç	Č	É	Ę	Ë	Ě	Í	Î	Ď
D	Đ	Ń	Ň	Ó	Ô	Ó	Ö	×	Ř	Ů	Ú	Ů	Ü	Ý	Ť	ß
E	ř	á	â	ã	ä	í	ć	ç	č	é	ę	ë	ě	í	î	ď
F	đ	ń	ň	ó	ô	ó	ö	÷	ř	ů	ú	ů	ü	ý	ť	·

Windows CE

13. Peripheral Devices

13.1 Activation of a Serial Interface RS 232

Your Cash Register can be equipped with up to 6 interfaces.

Location of interfaces (rear view)

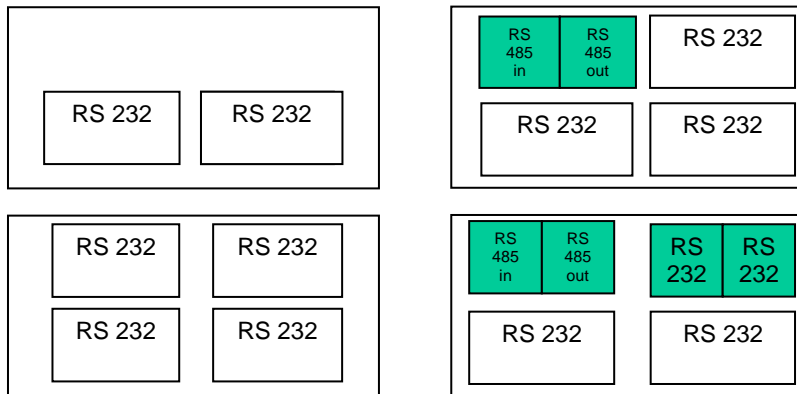

Each of the interfaces can be used after the activation. However, you may choose any interface for a peripheral device once it has been activated. You may program the Identification Number of the peripheral devices to be used. Note that the interface RS 485 is reserved for a Cash Register network. For the Scanner use only the interface named SCANNER because this connector is equipped with the separate power supply (5 +) for the Scanner.

13.2 Cables

The pin-layout of the serial ports of the QUORION cash registers is the same as the pin-layout of a serial port of a computer.

13.2.1 PC-Cable

For the connection between a Cash Register and a PC (QProg) you need a standard 9-pin **cross wired** computer cable which has **all signals connected**.

CR-12xx		COMPUTER
9-PIN male		9-PIN male
2 - RXD	↔	3 - TXD
3 - TXD	↔	2 - RXD
4 - DTR	↔	6 - DSR
5 - GND	↔	5 - GND
6 - DSR	↔	4 - DTR
7 - RTS	↔	8 - CTS
8 - CTS	↔	7 - RTS

13.2.2 Printer-Cable

For the connection between Cash Register and an external printer you need a standard 9 to 25-pin **cross wired** printer cable.

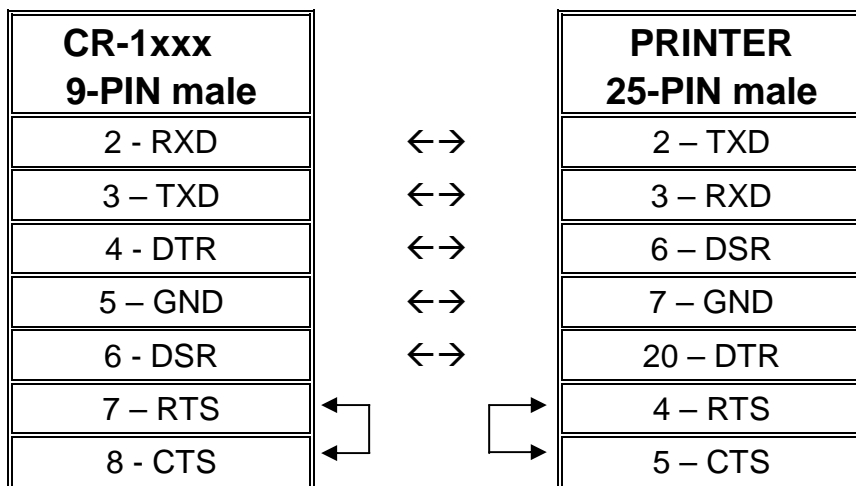

14. Error Messages

ID	Error Description		
1	Invalid Entry	21	Discount not Allowed
2	Invalid Time	22	Correct not Allowed
3	Invalid Date	23	Already Discounted
4	Invalid Article	24	Enter Quantity
5	Unknown Report	25	Journal Full
6	Invalid Function	26	
7	Transbuf. Full	27	
8	Still in Transaction	28	Wrong Clerk
9	User Break	29	
10	No Under/Tender	30	Print Invoice
11	Still in Tender	31	Receipt Paper End
12	Scanning Error	32	Journal Paper End
13	Select Clerk	33	Slip No Paper
14	Select Salesperson	34	Logging Error
15	Item not Sold	35	KP Error
16	No Price Entered	36	
17	No Zero Price	37	Invoice Buffer Full
18	Closed Drawer	38	
19	Manager Required	39	PLU File Full
20	Entry to High	40	Reindex PLU File

15. Test Routines

There are a number of procedures available in the register which can be used to test the hardware, reset the reports and test the transaction load by simulating transactions. The tests are started by entering a number on the TYPE key. The following are available:

301 – PRINTER FONT TEST PROCEDURE

1. Turn Lock to P (also X or Z when allowed)
2. Enter 301 on the TYPE key
3. The register will print the version information on the receipt printer.
 - P: D0040429 → Flash ROM version
 - C: CR1200 → Standard-Configuration
 - D: 00-LT1322-WE → Printer driver version
 - RAM: 256K → Total Memory
 - Serial # → 5065562
4. Printout of complete font table
5. Finished

302 (or 303) – ALL DISPLAY TEST PROCEDURE

1. Turn Lock to P (also X or Z when allowed)
2. Enter 302 (or 303) on the TYPE key
3. Display Test Start and all characters (0x20 to 0xFF) in all available modes are displayed.
4. Finished

305 – VERSION PRINT PROCEDURE

1. Turn Lock to P (also X or Z when allowed)
2. Enter 305 on the TYPE key
3. The register will print the version information on the receipt printer.
 - P: D0040429 → Flash ROM version
 - C: CR1200 → Standard-Configuration
 - D: 00-LT1322-WE → Printer driver version
 - RAM: 256K → Total Memory
 - Serial # → 5065562

306 – RE-INIT PRINTER LOGO'S

1. Turn Lock to P (also X or Z when allowed)
2. Enter 306 on the TYPE key
3. The Printer logo('s) will be sent to the printer controller. all available modes are displayed.
4. Finished

400 – DIRECT TRANSACTION TEST

1. Turn Lock to P (also X or Z when allowed)
2. Enter the number of transaction on the X key if not entered then 10 transactions is default
3. Enter 400 on the TYPE key
4. The register will use the REGISTER number as CLERK and SALESPERSON number when programmed else it will use CLERK 1 and SALESPERSON 1.

5. The register will now make a sale of 10 articles. The articles used depend on the register number. It will use article 1 to 10 and add the REGISTER x 10. So on register 1 it will use article 11 to 20.
6. The transaction is closed on TENDER 1.
7. Finished

401 – TABLE TRANSACTION TEST

1. Turn Lock to P (also X or Z when allowed)
2. Enter the number of transactions on the X key if not entered then 10 transactions is default
3. Enter 401 on the TYPE key
4. The register will use the REGISTER number as CLERK and SALESPERSON number when programmed else it will use CLERK 1 and SALESPERSON 1.
5. The register will use the REGISTER number as TABLE number when programmed else TABLE 1 is used.
6. The register will now make a sale of 10 articles. The articles used depend on the register number. It will use article 1 to 10 and add the REGISTER x 10. So on register 1 it will use article 11 to 20.
7. The transaction is closed on PB FUNCTION 1 (Close Balance)
8. Finished

402 – DIRECT TRANSACTION TEST

1. Turn Lock to P (also X or Z when allowed)
2. Enter the number of transaction on the X key if not entered then 10 transactions is default
3. Enter 402 on the TYPE key
4. The register will use CLERK 1 and SALESPERSON 1.
5. The register will now make a sale of 10 articles. It will use article 1 to 10.
6. The transaction is closed on TENDER 1.
7. Finished

403 – TABLE TRANSACTION TEST

1. Turn Lock to P (also X or Z when allowed)
2. Enter the number of transactions on the X key if not entered then 10 transactions is default
3. Enter 403 on the TYPE key
4. The register will use CLERK 1 and SALESPERSON 1.
5. The register will use TABLE 1.
6. The register will now make a sale of 10 articles. It will use article 1 to 10
7. The transaction is closed on PB FUNCTION 1 (Close Balance)
8. Finished

4444 – RESET REPORTS AND COUNTERS

1. Turn Lock to P
2. Enter 4444 on the TYPE key
3. The register will use now clear all reports, tables and reset the receipt and invoice counters.
4. It will print on the journal MESSAGE# 68 (SYSTEM CLEAR)
5. Finished

16. Battery operated system CR1200

As an option the Cash Register can be equipped with internal battery.

Attention: You must recharge the Accumulator, before the first working of machine.

1. The maximum battery charge is reached after 8 hours of recharging time (7,2 Ah)
2. The capacity is sufficient for normal operation anywhere from 6 to 10 hours, depending upon quantity and size of printed receipts (**Standard:** 4h with 60 receipts, 15 lines each in turn with 16 characters).
3. The red blinking warning light is located below the operator lock and activates, when the end of the normal operating time is reached, while printing is in progress. Only once the user has reached the end of normal operating time does the red light blink permanently.
4. At the end of the reserve operating time (roughly 1 hours) it is possible to turn the cash register back on after it has been turned off and recharged for 10 to 20 minutes.
5. Forced shut down due to low battery power protects the battery from being completely discharged. There is no warning before forced shut down takes place.
6. Cash register operation is permitted during recharging. Although the recharge time will of course be longer. A green LED light indicates the recharge process.
7. Cash register operation can also take place via external power from outlets via an adapter or car battery.
8. Recharge adapter:
 - a. AC/DC-Adapter > 15W; Output 12-28VDC (or Car-Battery),
or AC/AC-Adapter > 15W; Output 12-18VAC (Transformer);
 - b. Connection: Hollow plug 5,5 mm x 2,5 mm; not polarized